

Varenummer: 03445035
Beskrivelse: Fluro Heavy Duty Ledleje GE 35 EW-2RS
Hul Ø35
Note: 35

Mål

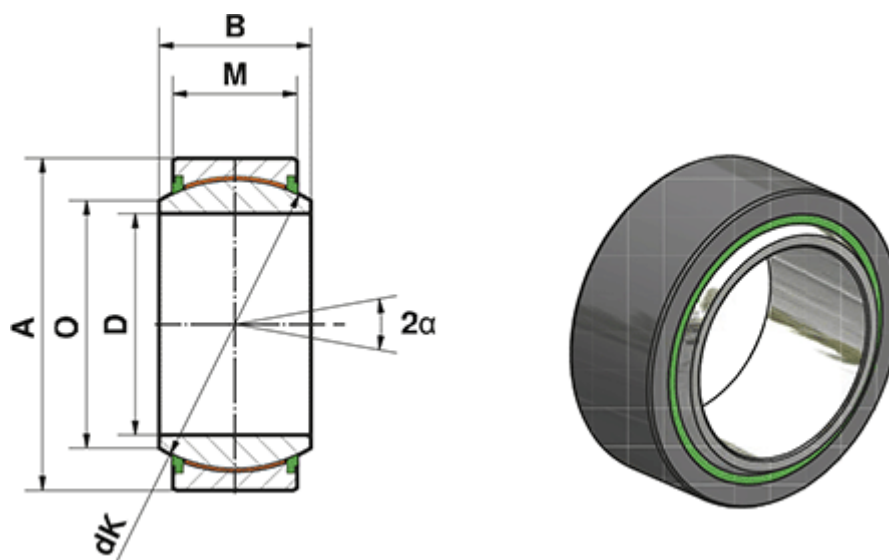

A	= 55	Statisk belastning C0 (kN) = 350
a (grader)	= 6	Vægt (g) = 220
B	= 25	
D	= 35	
dK	= 47	
Dynamisk belastning C (kN)	= 210	
M	= 20	
O	= 39.7	